

DOUBLE HYDRAULIC FORK POSITIONER 4000KG JCB Q-FIT

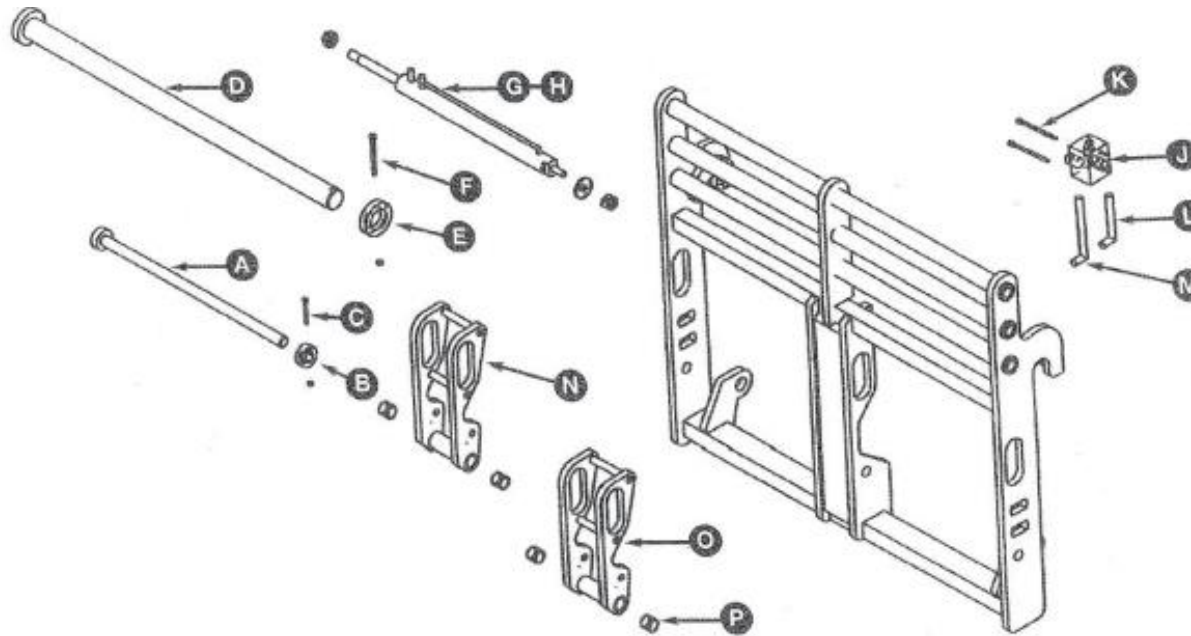

ITEM	PART NO.	DESCRIPTION	QTY	ITEM	PART NO.	DESCRIPTION	QTY
A	106251-20	Bottom Guide Bar	1	J	106251-21	Hydraulic Valve	1
B	106251-17	Retaining Collar	1	K	106251-24	Rubber Mounting c/w Bolts	2
C	106251-16	Hex HD Bolt	1	L	106251-22	Hose Assembly	2
D	106251-14	Pallet Fork Carrying Bar (57 dia)	1	M	106251-23	Hose Assembly	2
E	106251-18	Retaining Collar	1	N	106251-6	Right Hand Actuator	1
F	106251-15	Hex HD Bolt	1	O	106251-8	Left Hand Actuator	1
G	106251-11	Hydraulic Cylinder	2	P	106251-12	Bush	4
H	020	Seal Kit	2				